



Set-up Instructions for 20x40 meter Junior Classic Arena

Please take a moment to read through the entire directions before setting up your Burlingham Sports Arena. These instructions will guide you step-by-step through the process of assembly. If you should have any difficulty or question please call us at **800-446-0134**

Included In Your Shipment:

42 Rails
36 Line Posts
4 Corner Posts
2 End Posts
40 Post Caps
2 Ball Caps for End Posts
42 Post Stakes

14 sections on 40 meter side
7 sections on 20 meter side

What You Need:

Hammer
40 Meter Tape Measurer
120 Meters of Twine or String
Phillips-Head Screwdriver

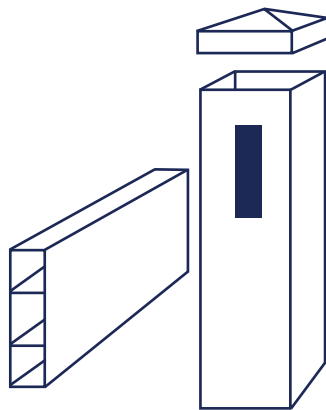

Rail, Line Post,
And Post Cap

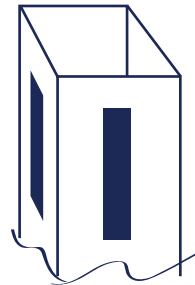

Corner
Post

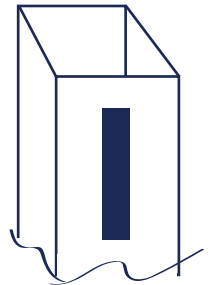

End
Post

Preparation:

- 1. Drag or blade the arena surface** – level and smooth as possible.
- 2. Locate and count all parts** – Separate line posts, corner posts, and end posts.
- 3. Deposit rails and posts** – Place the pieces around the outside perimeter where the arena will stand. This is to get the pieces close to where they will be installed.

Layout Your Arena

- 1. Find the center point** – Assuming you want your arena centered atop the footing you will need to find the center point of our surface. Measure the long side from edge to edge. Mark the center point. Measure the short side from edge to edge and mark the center point. Bring the center points together to find the center of your arena (*see diagram 1*).
- 2. Locate short side line** – From the center point measure 20 meters toward the short side; This is where your short side will line up (*see diagram 1*).
- 3. Locate long side line** – From the center point measure 10 meters toward the long side; This is where your long side will line up (*see diagram 1*).
- 4. Locate first corner** – The point where the two side lines intersect is the corner of your arena. Insert a stake at this point, make sure the stake is solidly in the ground with about 18" exposed. Place a corner post over this stake. 1"–2" of the stake should extend above the post to allow the guide string room to tie (*see diagram 2*).
- 5. Locate second corner, layout first long side** – From the first corner stake, measure down the long side to 40 meters. Keep in mind the center point of the arena to make the line square with the footing. Insert a stake at this point and place a corner post over the stake. This is your first long side.
- 6. Layout first short side** – From the second corner, measure across the short side 20 meters. Use the 3-4-5 formula (*see diagram 3*) to get the corner square. Place a stake at this point and place a corner post onto the stake. Now tie a string between the two stakes. This is your first short side.
- 7. Layout second short side** – From the first corner, measure across the short side 20 meters. Use the 3-4-5 formula (*see diagram 3*) to get the corner square. Place a stake at this point and place a corner post onto the stake. Now tie a string between the two stakes. This is your second short side.

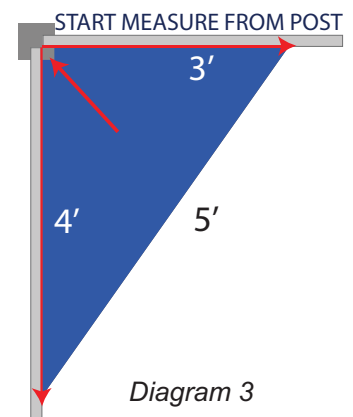
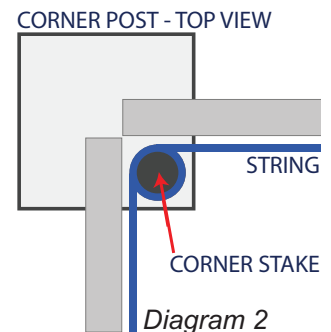
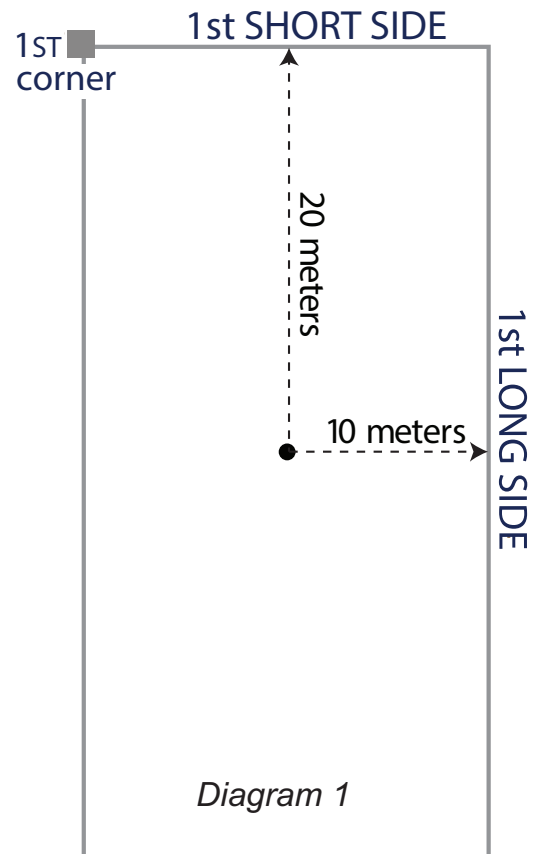

- 8. Layout second long side** – Tie a string between the two stakes to layout your second-long side. You may need to adjust one of the short side stakes to get the arena square.

Now is the time to overview where your Dressage Arena is located. If you don't like the positioning make the necessary adjustments.

Arena Assembly

- 1. Build out the first long side** – Place the rail into the corner post butting up to the rail from the other hole (see *diagram 2*). Place a line post on the end of the rail. Make sure all rails butt up against each other in the middle of the post. Repeat these steps until you are at the Second Corner.

NOTE: You may need to adjust the position of the second corner after building out the first long side. This is normal and is due to the variations of measuring out the arena. When the arena is set-up correctly the measurement from inside rail to inside rail will be 40 meters on the long side and 20 meters on the short side.

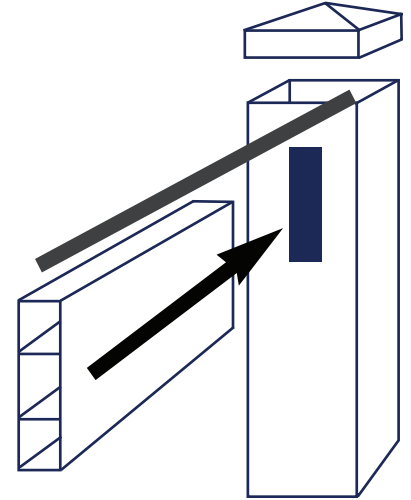

- 2. Build out first short side** – Continue assembly of the post and rail using the method described above. The guide string between the corner stakes is used to keep the line straight as you build to the next corner.
- 3. Build out second long side** – As above.
- 4. Build out second short side and entrance area** – As above. Use the end posts for entrance gate.
- 5. Place and hammer in stakes** – Place a stake in every post. The stake goes in the hole within the square tube in the corner of the post. Hammer in all stakes till they are flush with the top of the posts. **CAUTION:** Hitting the PVC post with your hammer may damage the post.
- 6. Place caps on posts** – Secure caps on post tops. Use the Ball Caps on the end posts at the entrance.

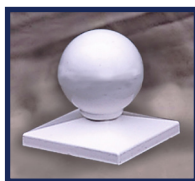

Maintaining Your New Dressage Arena

Your new arena is made from sturdy PVC. This material is UV treated for sun and light impact. Aside from a thorough cleaning from time to time, your arena is basically maintenance free. To clean your arena, use water and mild detergent with a sponge or soft cloth as abrasives may scratch the finish. To get out stubborn stains use mineral spirits followed by a water rinse. Use mineral spirits lightly as it can damage the finish.

Once the arena is set up, rails should be turned over every 2-3 months to prevent sagging. When moving your arena, be sure to lay flat and not let rails bend while in transit. Arena is safe to leave out in all weather conditions, however in extreme cold, rails are more susceptible to damage with any impact.

Storage: Wash sand off rails to prevent scratching. Rails must lie on a smooth, flat surface.



BURLINGHAM
SPORTS

www.AdamsHorseSupply.com

877-322-7387